

hp L1725  
P4827



[www.hp.com/go/monitorsupport](http://www.hp.com/go/monitorsupport)

17-inch LCD monitor  
(17-inch viewable image)

user's guide



invent

Notice

Important Safety Instructions

What the hp L1725 Monitor Offers

Setting Up the Monitor

Removing your monitor's pedestal

How to Install the Drivers

Adjusting the Monitor

Using the Monitor

Troubleshooting

LCD Monitor Quality and Pixel Policy

Technical Specifications

Care and Cleaning

Environmental Information

Regulatory Information



i n v e n t

**hp** L1725  
P4827

17-inch LCD Monitor  
(17-inch Viewable Image)

User's Guide

## Notice

The information contained in the documents accompanying this product is subject to change without notice.

Hewlett-Packard makes no warranty of any kind with regard to this material, including, but not limited to, the implied warranties of merchantability and fitness for a particular purpose.

HP shall not be liable for errors contained herein or for incidental or consequential damages in connection with the furnishing, performance, or use of this material.

HP assumes no responsibility for the use or reliability of its software on equipment that is not furnished by HP.

These documents contain proprietary information that is protected by copyright. All rights are reserved. No part of these documents may be photocopied, reproduced, or translated to another language without the prior written consent of HP.

Hewlett-Packard France  
Business Desktops Division  
Grenoble  
Cedex 9  
France

© Copyright Hewlett-Packard Company, 2002. All rights reserved.

Hewlett-Packard is a registered trademark of Hewlett-Packard Company in the United States of America and other countries. Other brand or product names are trademarks of their respective holders.

---

## Important Safety Instructions



---

**WARNING:** The lightning flash with arrowhead symbol inside an equilateral triangle is intended to alert the user to the presence of uninsulated, dangerous voltage which may be of sufficient magnitude to constitute a risk of electric shock.

---



---

**WARNING:** The exclamation point within an equilateral triangle is intended to alert the user to the presence of important operating and servicing instructions in the literature accompanying the appliance.

---

---

**WARNING:** If you are unsure that you can lift the equipment safely, do not try to move it without help.

Before you connect any cables or install the HP monitor, refer to the above safety instructions. Also, refer to the set up poster and the documentation included with the PC and the video adapter to ensure this equipment is correctly installed.

For your safety, always connect equipment to a grounded wall outlet. Always use a power cord with a properly grounded plug, such as the one provided with the equipment, or one in compliance with your national safety standards. This equipment can be disconnected from the power by removing the power cord from the power outlet. This means the equipment must be located close to an easily accessible power outlet.

---

**WARNING:** Use the monitor with the power adapter supplied with your HP monitor only.

To avoid electrical shock, do not open the monitor cover or the power adapter. There are no user-

**serviceable parts inside. Only qualified service personnel should service these parts.**

**Make sure the computer is turned off before connecting or disconnecting a display peripheral.**

---

## **Working in Comfort**

To optimize your comfort and productivity, it's important that you set up your work area correctly and use your HP equipment properly. With that in mind, we have developed some setup and use recommendations based on established ergonomic principles for you to follow.

These recommendations can be found in the online version of the Working in Comfort guide, which is preloaded on the hard disk of your HP computer. They can also be found on the HP Working in Comfort Web site at [www.hp.com/ergo](http://www.hp.com/ergo) along with other information.

Before contacting customer services, please refer to the following HP web sites:

[www.hp.com/go/monitorsupport](http://www.hp.com/go/monitorsupport)

[www.hp.com/go/pcaccessories](http://www.hp.com/go/pcaccessories)

## What the hp L1725 Monitor Offers



The HP L1725 monitor is a liquid crystal display (LCD) 17-inch, high resolution, multi-synchronous color monitor. Multi-synchronous means that the monitor can be used with a range of video modes. It is optimized for use with all HP computers.

*The HP L1725 monitor has the following features:*

- A 17-inch LCD; thin film transistor (TFT) with an anti-glare, hard coated surface
- Support of video modes up to 1280 x 1024 at a 75 Hz refresh rate
- Analog/Digital interface: a VGA (analog) and a DVI-D (digital) connector enables connection to up to two computers at the same time.
- True color (16.7 million colors)
- Auto-adjustment of image position, clock, and phase for the VGA interface
- An onscreen display (OSD) manager that allows you to adjust all settings through onscreen menus.
- The monitor has VESA compliant mounting to allow for simple wall or arm mounting ([refer to "Removing your monitor's pedestal" on page 18](#)).
- Power-management system (VESA<sup>1</sup> standard) controlled from suitably equipped HP computers to automatically reduce the power consumption of the monitor

---

1. VESA is the Video Electronics Standards Association.

**NOTE:** As an ENERGY STAR partner, HP has determined that this product meets ENERGY STAR guidelines for energy efficiency.

---

- Compliance with stringent Swedish Low Emissions guidelines TCO '99
- Plug and Play capability (compliant with VESA DDC standard, version 3, revision 1 at level, DDC/2B, version 1) that enables the monitor to identify itself to suitably equipped HP computers
- Slot for security lock
- Monitor base is designed to accommodate HP's wireless satellite accessory, to provide a wireless office solution
- Height adjustment facility
- Pivot enabled to provide portrait-landscape option
- 180° (+/-) screen swivel angle
- Monitor base designed to accommodate up to 4 USB accessories (refer to ["Connecting additional devices to your monitor"](#) on page 17)
- Audio jacks
- Cable management system.



## Unpacking the Monitor

Check for the following items. If they are missing or damaged, consult your retailer immediately.

- 1 liquid crystal display (LCD)
- 1 power cord
- 1 DC adapter with an attached DC cable
- 1 video cable (VGA)
- 2 audio cables
- 1 USB cable
- 1 Quick User's Guide
- 1 warranty booklet
- 1 CD-ROM disc.

## Setting Up the Monitor

### Where to place the monitor

Place the monitor on a flat, sturdy surface. Ensure that the operating site is free from excessive heat and moisture. For best performance, make sure nothing is resting on the monitor.



**WARNING:** Before you connect any cables or install the HP monitor, refer to the safety instructions at the beginning of this manual. Refer also to the documentation that came with the computer to ensure this equipment is correctly installed.

### Connecting two computers to the monitor

The LCD monitor has two video signal connectors on the rear panel: one analog (VGA) and one digital (DVI-D). This allows you to connect the monitor to up to two computers at the same time.

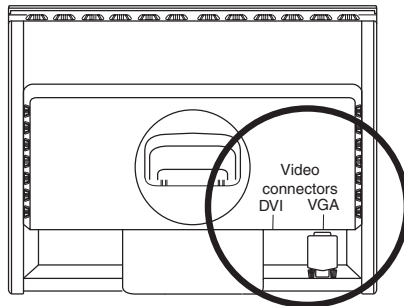

When two computers are connected, you need to use the Input Priority setting on the onscreen display (OSD) to specify which monitor input has priority. See [“Input Priority” on page 34](#).

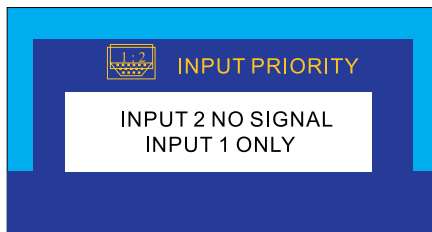

## Connecting the cables to the monitor

Look at the following diagram and follow the steps listed below to connect the cables to the LCD monitor.



---

**CAUTION:** This monitor is equipped with an auto-sensing power supply for voltage ranges 100—240 V AC, 50/60 Hz. Use the monitor with the supplied DC adapter only.

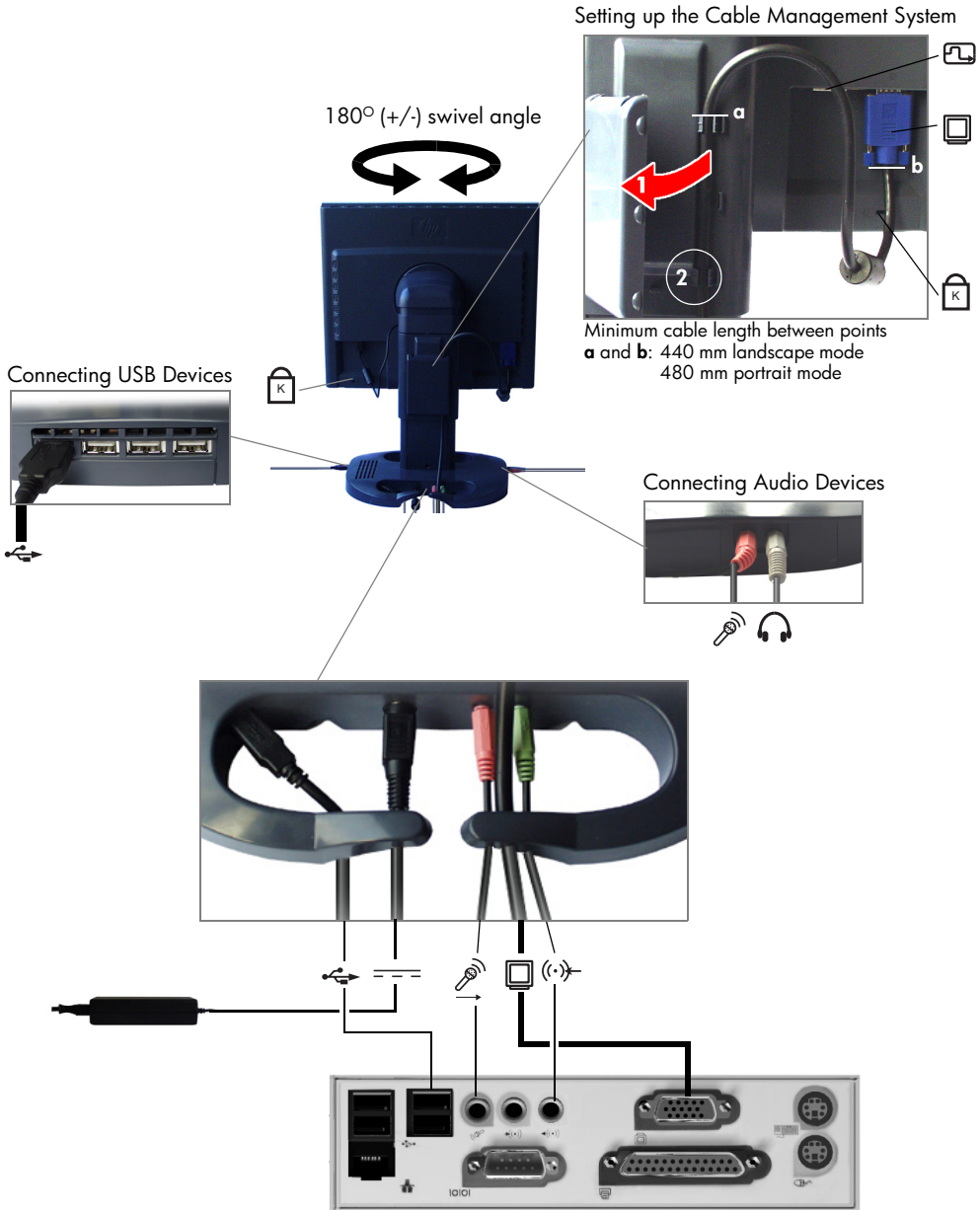

---

The back of your monitor will look like picture below:



To connect the cables to the monitor:

- 1 Make sure the computer is turned off.
- 2 Plug the video cable into the correct video connector (VGA or DVI-D) on the back of the monitor. Secure the cable by tightening the thumbscrews.

VGA cable →	VGA connector 
DVI-D cable →	DVI-D connector 

---

**NOTE:** All monitors are equipped with both a VGA and a DVI-D connector and come with a VGA cable. Using both video connectors, you can connect this monitor to up to two computers at the same time.

---

- 3 Open the cable management door and secure the video cable in the cable clips provided, making sure that the cable length is sufficient for the mode in which you will use your monitor (landscape or portrait). Refer to "[Setting up the Cable Management System](#)" in the picture on the previous page.

---





**NOTE:** To change your monitor's position or mode easily, make sure that the length of your video cable between points **a** and **b** is:

at least 480 mm in portrait mode  
at least 440 mm in landscape mode.

---

- 4 Route the video cable, using the cable management at the monitor's base, and plug it into the corresponding video connector on the computer.

- 5 Plug the audio cables into the correct connectors on the computer. Connect the green plug to the Audio Out connector and the pink plug to the Microphone connector on the computer.

	Connectors	
	Computer	Monitor
Green → Audio connector		
Pink → Microphone connector		



**CAUTION:** Do not connect the audio cable to the Speaker Out connector on the computer: the audio system of the monitor could be damaged. The audio cable must be connected to the Audio Out connector. HP recommends you keep the audio cable connected to the Audio Out connector on the computer at all times when using the monitor.

- 6 Plug the USB cable into the connector at the rear of the monitor's base and into a USB port on your computer.
- 7 Connect your USB devices (up to four) to the monitor's USB ports. Refer to "[Connecting USB Devices](#)" in the picture on [page 11](#).
- 8 Plug the DC adapter cable into the connector at the rear of the monitor base.  
Make sure the DC In cable is connected from the monitor column to the back of the LCD panel. This cable should always be connected.
- 9 Plug the power cord into the DC adapter.
- 10 Turn on the main power source (for example, a surge protector), and then turn on the power switch for both the computer and the monitor.

*To disconnect the cables from the monitor:*

- 1 Turn off the power switch for the monitor and the computer, and then turn off the main power source.
- 2 Disconnect the power cord from the main power source and the DC adapter cable.
- 3 Disconnect the DC adapter cable from the connector at the rear of the monitor base.
- 4 Disconnect the audio cables from the computer connectors.
- 5 Disconnect your USB devices from the monitor's USB ports.
- 6 Unscrew the thumbscrews on the video cable(s) and disconnect the video cable(s).

### **Securing your monitor**

Your monitor can be secured to a desk or to any other fixed object, using a security lock cable. The cable can be attached a slot located on the rear of the monitor.

---

**NOTE:** The security lock is not an HP accessory. It cannot be ordered from HP. Contact your retailer for more information.

---

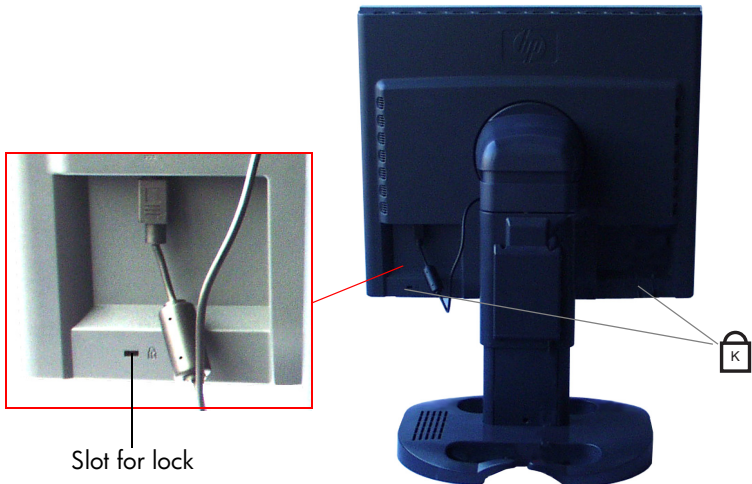

*To secure the monitor:*

- 1 Insert the lock in one of the two slots located on the rear of the monitor.
- 2 Turn the key to lock the cable to the monitor.
- 3 Remove the key and store it in a safe place.



## Changing your monitor's viewing position

*To tilt your monitor:*

Firmly push or pull the lower part of the screen.

*To change your monitor to portrait or landscape:*

Your monitor can be rotated to either a landscape or portrait position.

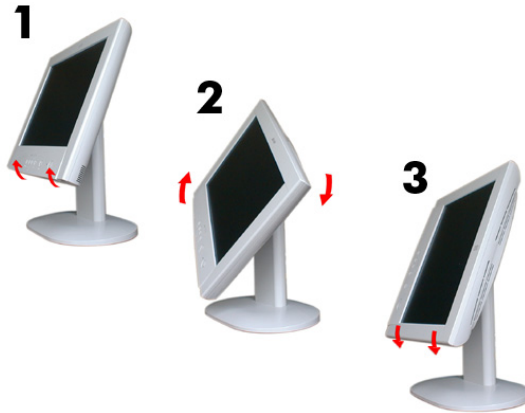



- 1 Tilt the lower part of the monitor upwards.
- 2 Rotate the monitor clockwise until the monitor controls are on the left side.
- 3 Firmly push the lower part of the monitor downwards to secure it in the new position.

## Connecting additional devices to your monitor

Additional devices can be connected to your LCD monitor.

There is one headphone connector and one microphone connector on the left side of the monitor's base. You can use these connectors to connect various compatible devices.

Black → Headphone connector	
Pink → Microphone connector	

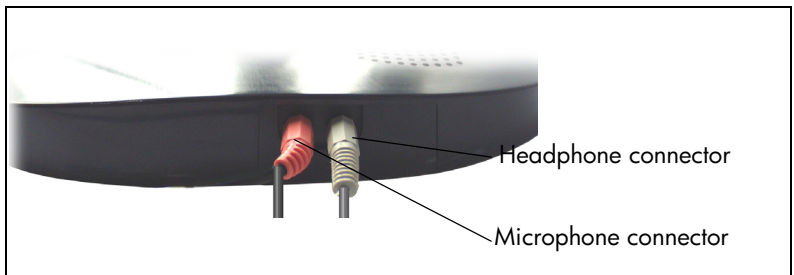

There are four of USB ports on the right side of your monitor's base, as shown in the picture below.

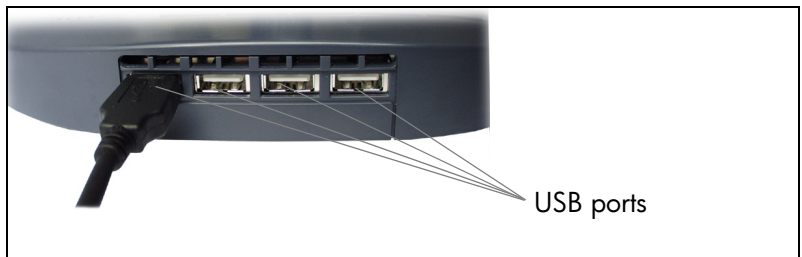

---

## Removing your monitor's pedestal

These HP LCD monitors are compliant with VESA Wall Mounting. You can remove the monitor's pedestal to mount the monitor on a wall.

---

**NOTE:** The VESA Wall Mount is not an HP accessory. It cannot be ordered from HP. Contact your reseller for more information.

---

**CAUTION:** **The LCD monitor is fragile.**

---

- 1 Place the monitor on a flat, clean surface.



---

**CAUTION:** **Be careful not to trap your fingers when carrying out step 2.**

---

- 2 **Pull** the plastic casing tabs apart (a), then **lift** off the casing (b) as shown in the pictures below.

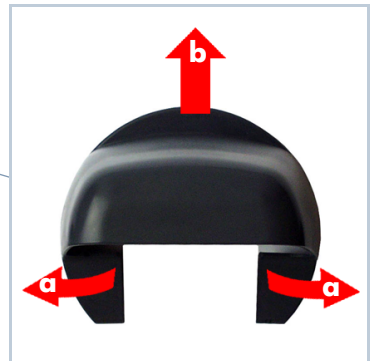

- 3 Unscrew the metal fixing.



- 4 **Lift** the pedestal from the monitor.
- 5 The monitor can now be mounted on a wall.



## How to Install the Drivers

The HP monitor comes with driver software that allows you to take advantage of the Plug and Play feature of the Windows® 95, Windows 98, Windows 2000, or Windows XP operating system. This software enables the computer to communicate with the monitor and use all the monitor features. Without this software, the monitor settings and display images will not be correct.

---

**NOTE:** HP computers may be shipped with the Plug and Play drivers preinstalled. If you have an older computer, these drivers may not be preinstalled and you may need to install the drivers from the CD-ROM disc that came with the monitor.

---

You can also download the latest version of a driver from the HP Monitors Support web site at:

[www.hp.com/go/monitorsupport](http://www.hp.com/go/monitorsupport)

### Windows 95 and 98 Users

- 1 Click on **Start**, select **Settings**, then click **Control Panel**.
- 2 Double click on **Display**.
- 3 Click on the **Settings** tab.
- 4 Click on **Advanced Properties** or **Advanced** and select the **Monitor** tab.
- 5 Click on **Change** to select the model of the HP Monitor you are using.
- 6 Click on **Have Disk**.
- 7 Click on **Browse** to find the \*.INF file on your CD-ROM in the root directory and click on **OK**.

Select your monitor type from the **Models** box and click on **OK** to install the selected monitor.

## Windows 2000 and XP Users

---

**NOTE:** The procedure for installing the driver for your operating system may vary.

---

*To install the driver:*

- 1 Click **Start**, select **Settings**, then click **Control Panel**.
- 2 Double-click **Display**.
- 3 Select the **Settings** tab.
- 4 Click **Advanced Properties** or **Advanced**, and select the **Monitor** tab.
- 5 Click **Properties**.
- 6 Select the **Driver** tab.
- 7 Click **Update Driver** and click **Next**.
- 8 Select the recommended option and click **Next**.
- 9 Select the **Specify a Location** box.
- 10 Find and open the **\*.inf** file on the CD-ROM disc in the root directory, and click **OK**.
- 11 Click **Next** to install the selected monitor driver.

The operating system and your HP monitor are now set up to work together for the best performance.

If the installation procedure of the monitor driver for the Windows 95, Windows 98, Windows 2000, or Windows XP operating system is different, or if you need more detailed installation information, please refer to the Microsoft Windows information that came with the computer.

## Adjusting the Monitor

The monitor display has several adjustable settings which may need to be fine tuned occasionally. Adjust the monitor:

- When the monitor is installed for the first time.
- If the resolution (number of pixels on the display) or refresh rate (vertical scan frequency rate) has been changed.
- If the graphic card has been changed.
- If the monitor is connected to a different computer.
- After using the Mode Recall function. See [“To use Mode Recall” on page 32.](#)

---

**NOTE:** For best performance, it is recommended that you select a video mode of 1280 x 1024 @ 60 Hz.



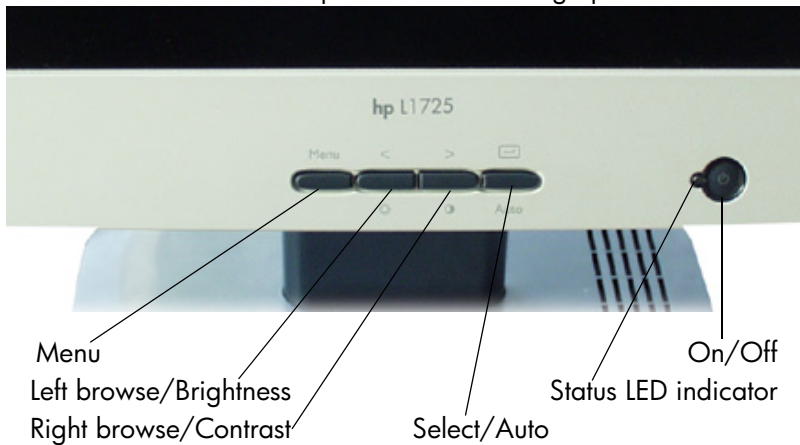

---

### Using the monitor controls

There are five controls that perform the following operations:



## Monitor control buttons

Control button/icon	Function when not in Display Manager	Function in Display Manager
	Menu: Opens and closes the Display Manager window	Closes setting screens and exits Display Manager
	Left Browse/Brightness: Shortcut to Brightness setting screen	Navigates through setting option icons and adjusts settings
	Right Browse/Contrast: Shortcut to Contrast setting screen	Navigates through setting option icons and adjusts settings
	Select/Auto: (only when the VGA input is selected) Performs an auto-adjustment which will optimize the image quality	Acts as an Enter (Select) key to select setting screen options
	On/Off: Turns the monitor on or off	Turns the monitor on or off



## Using the Monitor

### Using the On-Screen Display Manager (OSD)

The monitor comes pre-configured to provide the best viewing image. However, you can fine-tune the display using Display Manager. The monitor has control buttons that you can use to open the On-Screen Display Manager to select and adjust display settings.

*To adjust display settings:*

- 1 Press the Menu button **MENU** to open the On-Screen Display Manager.
- 2 Press a Browse button **< >** to navigate through the setting option icons; see the setting options table on the next page.
- 3 When the menu option you want is selected, press the Select button **↵** to open the setting screen for that option.
- 4 Adjust the setting using the onscreen instructions that follow.
- 5 To exit Display Manager, press the Menu button **MENU**.

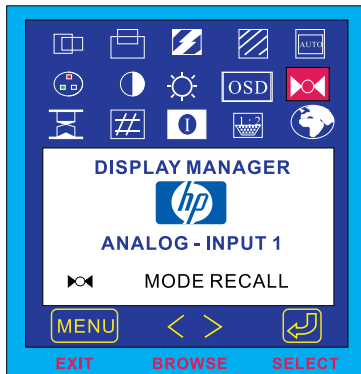

On-Screen Display Manager screen in analog mode (VGA)



On-Screen Display Manager screen in digital mode (DVI)

### Setting Options

The icons at the top of the On-Screen Display Manager window represent the different setting options, shown in the table on the following page:

Icon	Setting option	Setting description
	Horizontal Position*	Adjusts the horizontal position of the screen image.
	Vertical Position*	Adjusts the vertical position of the screen image.
	Clock*	Adjusts the frequency of the pixel clock to minimize vertical bars.
	Phase*	Adjusts the phase value to minimize horizontal bars.
	Auto Config*	Auto-adjusts the vertical and horizontal position, producing a stable, centered image.
	Color	Adjusts the tint of white, and the red, green, and blue (RGB) mix for colors.
	Contrast	Adjusts the difference between the light and dark areas.
	Brightness	Adjusts the brightness.
	OSD Manager (OSD stands for on-screen display manager)	Adjusts the position, timeout, and notification features of the Display Manager window.
	Mode Recall	Resets the display to original factory settings for color, brightness, phase, and clock.
	Backlight Info	Shows the status of the light behind the panel.
	Serial Number	Shows the serial number of the display.
	Mode Info	Shows the current resolution and refresh rate; shows if you're in analog or digital mode; and shows how many user settings have been adjusted.
	Input Priority	Sets which video input is active: analog or digital. Shows status of the video input that is active.
	Languages	Shows the language of the OSD window.

---

**NOTE:** Horizontal Position, Vertical Position, Clock and Phase settings do not need to be adjusted for displays operating in digital mode (using the DVI input), therefore these icons do not appear in digital mode.

---

## Horizontal Position, Vertical Position, Clock, Phase, Contrast, or Brightness settings

To change Horizontal Position, Vertical Position, Clock, Phase, Contrast or Brightness settings:

- 1 Open the setting screen you want to adjust.  
See “Using the On-Screen Display Manager (OSD)” on page 24.

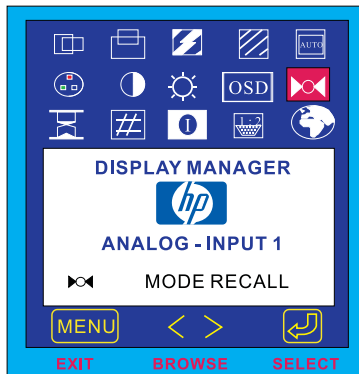

- 2 Press the Browse buttons to adjust the setting. The setting is automatically saved as you adjust it.

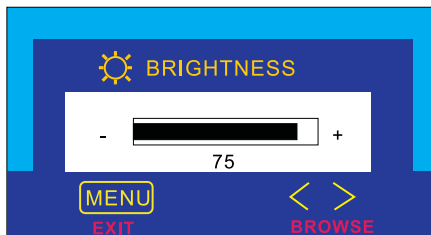

- 3 Press the Menu button to exit the setting screen.
  - If the viewable image is positioned too far too the right or left, you can adjust its horizontal position. In the Horizontal Position screen, pressing the left Browse button moves the horizontal position to the left, and pressing the right Browse button moves the horizontal position to the right.
  - If the viewable image is positioned too high or low, you can adjust its vertical position. In the Vertical Position screen, pressing the left Browse button moves the vertical position down, and pressing the right Browse button moves the vertical position up.
  - If vertical bars appear on your screen you can reduce or eliminate them using the Clock function. In the Clock screen, pressing the left Browse button decreases the frequency of the sampling clock for VGA signals, and pressing the right Browse button increases the frequency.
  - If horizontal bars appear on your screen, you can reduce or eliminate them using the Phase function. In the Phase screen, pressing the left Browse button decreases the phase of the VGA signal sampling, and pressing the right Browse button increases the phase.
  - If the display seems too sharp, you can adjust the contrast setting. In the Contrast screen, pressing the left Browse button decreases the contrast, and pressing the right Browse button increases the contrast.
  - If the display appears too bright or dim, you can adjust the brightness. In the Brightness screen, pressing the left Browse button decreases the brightness, and pressing the right Browse button increases the brightness.

### **Auto-Adjustment function**

For the best image quality from your HP LCD monitor, you may need to adjust VGA specific parameters such as position, phase and clock.

---

**NOTE:** The following procedure only applies when using the VGA interface, it is not required when using the DVI interface.

---

To auto-adjust these parameters:

- 1 Access the auto-adjustment function by pressing the Select/Auto button on your monitor, then choosing the Auto option from the OSD menu.
- 2 If the result is not satisfactory, open the “auto adjustment pattern.exe” file on the CD-ROM provided, and repeat step 1.
- 3 If the result is not satisfactory, use the test-pattern on the CD-ROM provided, access the OSD menu and manually adjust the clock and phase first, then the horizontal/vertical position.

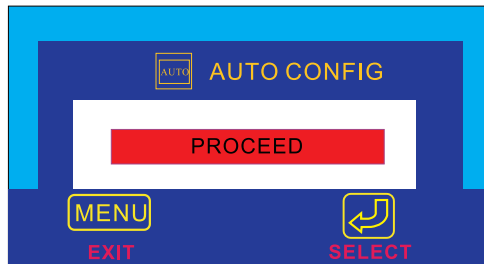

## Color settings

*To change Color settings*

If the color of your display is not satisfactory you can alter the color settings. Open the Color settings screen. See [“Using the On-Screen Display Manager \(OSD\)” on page 24](#). Four options appear: Bluish, White, Reddish, and User. Bluish, White, and Reddish refer to predefined color temperature. The User setting lets you manually adjust the red, green, and blue (RGB) mix for color generation.

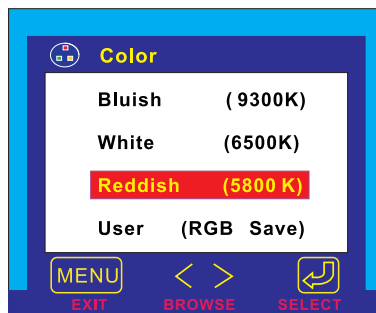

*To adjust the Color temperature:*

- 1 Press the Browse buttons to select a color temperature.
- 2 Press the Menu button to save the setting and exit the setting screen.

*To adjust User Color:*

- 1 Press the Browse buttons until User is selected.
- 2 Press the Select button to open the User Color window.

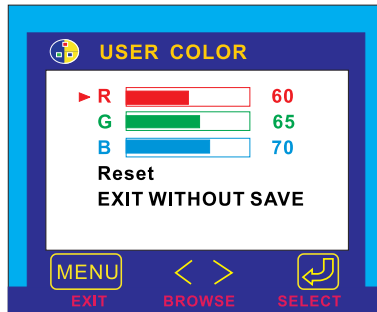

- 3 Press the Browse buttons to select the color you want to adjust.
- 4 Press the Select button to activate the adjustable setting for the color.
- 5 Press the Browse buttons to change the color value. The value is automatically saved as you change it.
- 6 Press the Menu key to exit the setting screen.

*To reset the color settings:*

If you adjust a color value and the result is unsatisfactory, you can choose to keep the color values as they were before any adjustments were made by selecting **EXIT WITHOUT SAVE** and pressing the Menu key.

You can reset the values to the original factory color settings even after exiting the Color menu.

- 1 Access the Color settings OSD.
- 2 Press the browse buttons to open the User Color window.
- 3 Use the browse buttons to select Reset.

## OSD settings

To change OSD settings:

- 1 Open the OSD setting screen. See “Using the On-Screen Display Manager (OSD)” on page 24. Five options appear: Protected OSD, OSD Timeout, Inform On/Off, H Position, and V Position.

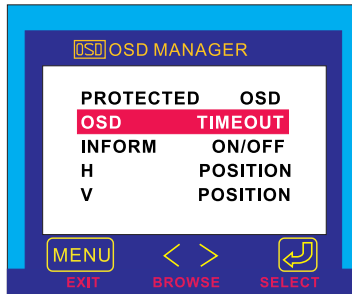

- 2 Press the Browse buttons to select the option you want to adjust.
- 3 Press the Select button to display its setting screen.

To activate the Protected OSD:

Using the Protected OSD function allows you to protect the OSD settings.

- 1 You will be prompted to type a password. Type 040990.
- 2 Use the browse buttons to select Yes to protect an OSD, and No to deactivate the Protected OSD function.
- 3 Press the Menu button to exit the setting screen.

To adjust OSD Timeout:

You can set the OSD (Display Manager) screen to turn off automatically when you are not using it.

- 1 Press the Browse buttons to select how long the Display Manager screen appears before automatically turning off. The setting is automatically saved as you adjust it.
- 2 Press the Menu button to exit the setting screen.

*To adjust Inform On/Off:*

Turning Inform on displays the chosen resolution and refresh rate for three seconds, whenever you change them. Turning Inform off prevents this information from being displayed.

- 1 Press the Browse buttons to select On or Off. The setting is automatically saved as you adjust it.
- 2 Press the Menu button to exit the setting screen.

*To adjust OSD H Position:*

You can adjust the horizontal position of the OSD (Display Manager) screen.

- 1 Press the Browse buttons to position the OSD screen. The setting is automatically saved as you adjust it.
- 2 When the screen is in the horizontal position you want, press the Menu button to exit the setting screen.

*To adjust OSD V Position:*

You can adjust the vertical position of the OSD (Display Manager) screen.

- 1 Press the Browse buttons to position the OSD screen. The setting is automatically saved as you adjust it.
- 2 When the screen is in the vertical position you want, press the Menu button to exit the setting screen.

## **Mode Recall**

Using Mode Recall restores the original default settings for Color, Brightness, Phase, and Clock. If you make manual adjustments that are unsatisfactory, you can use this function to restore the original settings.



### To use Mode Recall

- 1 Open the Mode Recall setting screen. See “Using the On-Screen Display Manager (OSD)” on page 24. A window with a red bar appears.

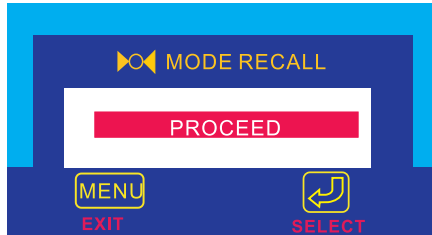

- 2 Press the Select button to proceed with Mode Recall, or press the Menu button to exit without resetting.
- 3 If you reset with Mode Recall, press the Menu button to exit the setting screen.

### Backlight Info

The Backlight Info window shows the elapsed time of usage for the light behind the display screen. The expected lifespan of the backlight is approximately 30,000 to 40,000 hours. At some point after the maximum usage time of the backlight has been exceeded, you may notice a decrease in brightness of up to 50%. At this point, the backlight needs to be replaced to restore full brightness.

---

**WARNING:** The backlight can be replaced only by a trained technician. Please contact the HP Support Center for assistance. Do not attempt to replace the light yourself.

---

**NOTE:** Do not use a screen saver with the LCD monitor, as the backlight will be used. It is recommended that you enable an automatic power saving mode on the PC, or switch off the monitor when not in use.

---

*To view Backlight Info:*

- 1 Open the Backlight Info setting screen. See [“Using the On-Screen Display Manager \(OSD\)” on page 24](#). The elapsed time is displayed.
- 2 Press the Menu button to exit the setting screen.

## **Serial Number**

You may need to provide the display serial number to HP Support technicians to help them serve you better during a Support call.

*To view a Serial Number:*

- 1 Open the Serial Number setting screen. See [“Using the On-Screen Display Manager \(OSD\)” on page 24](#). The serial number is displayed.
- 2 Press the Menu button to exit the setting screen.

## **Mode Info**

The Mode Info screen shows whether the current video input mode is analog (1) or digital (2); shows the current resolution and refresh rate; and shows how many User settings you have changed, and how many preset settings have not been changed.

*To view Mode Info:*

- 1 Open the Mode Info setting screen. See [“Using the On-Screen Display Manager \(OSD\)” on page 24](#). The Video Input mode, the resolution and refresh rate, and the number of Preset and User values are displayed.
- 2 Select the Preset or User values with the Browse buttons.
- 3 Press the Select button. The Preset or User mode information screen is displayed.
- 4 Press the Menu button to exit the setting screen.

## Input Priority

When connecting two computers to the monitor (one VGA input and one DVI input), the input priority selects the image that will be displayed. (1) represents VGA and (2) represents DVI.

You can use this setting to switch between the two video inputs, analog and digital. The default active video input is analog (1).

*To set Input Priority:*

- 1 Open the Mode Info setting screen. See [“Using the On-Screen Display Manager \(OSD\)” on page 24](#).
- 2 Press the Browse buttons to switch between Input 1 (analog) and Input 2 (digital).
- 3 Press the Select button to confirm the new setting. A confirmation screen is displayed.
- 4 Press the Menu button to exit the setting screen.

## Language of On-Screen Display Manager

You can choose to view the On-screen Display Manager in English, German, French, Italian, or Spanish.

*To change the language of Display Manager:*

- 1 Open the Languages setting screen. See [“Using the On-Screen Display Manager \(OSD\)” on page 24](#).
- 2 Press the Browse buttons to choose the language you would like. The setting is automatically saved.
- 3 Press the Menu button to exit the setting screen.

## Troubleshooting

If you are having trouble with the monitor, these tips may help you solve the problem. Try the following steps before calling HP.

If you find:

*No picture and the light indicator on the front of the LCD panel is off:*

- Check that the monitor is turned on.
- Check that the power cord is properly connected.
- Check the electrical outlet.
- Connect the monitor to another computer to determine if there is a problem with the computer rather than with the monitor.

*No picture and the light indicator on the front of the LCD panel is on:*

- Check that the computer is turned on.
- Check that the monitor is not in power-saving mode.
- Adjust the Contrast and Brightness through the onscreen display or the control buttons.
- Check that the video cable has no bent pins.
- Connect the monitor to another computer to determine if there is a problem with the computer rather than the monitor.

*Picture is fuzzy:*

- Adjust the monitor using the Auto-Adjustment function. See [“Auto-Adjustment function” on page 27](#).
- If you are running the Windows 95 or 98, Windows 2000, or Windows XP operating system, install the Plug and Play driver (\*.inf file). See [“How to Install the Drivers” on page 20](#).
- Change the resolution to the recommended resolution of 1280 x 1024 @ 60 Hz.

*Pixels are missing:*

- See [“LCD Monitor Quality and Pixel Policy” on page 37](#).

*Colors are not pure:*

- Check that the video cable has no bent pins and is firmly attached to both the computer and monitor video connectors.
- Restore the original factory colors setting. See [“To use Mode Recall” on page 32](#).
- Adjust the RGB (red, green, and blue) colors. See [“To change Color settings” on page 28](#).

*Picture is not centered:*

- Adjust the monitor using the Auto-Adjustment function. See [“Auto-Adjustment function” on page 27](#).

*No sound (selected models only):*

- Make sure that the DC cable is properly connected to the base of the monitor.
- Make sure the main power supply is turned on.
- Check to see if the audio cable is plugged in properly.
- Adjust the volume setting on the audio base and the keyboard. Make sure the Mute setting on the keyboard and in the Volume Controls of the computer is turned off.

## LCD Monitor Quality and Pixel Policy

The HP L1725 TFT monitor uses high-precision technology, manufactured according to HP standards, to guarantee trouble-free performance. Nevertheless, the display may have cosmetic imperfections that appear as small bright or dark spots. This is common to all LCD displays used in products supplied by all vendors and is not specific to the HP P4827 displays. These imperfections are caused by one or more defective pixels or sub-pixels.

- A pixel consists of one red, one green, and one blue sub-pixel.
- A defective whole pixel is always on (a bright spot on a dark background), or it is always off (a dark spot on a bright background). The first is the more visible of the two.
- A defective sub-pixel (dot defect) is less visible than a defective whole pixel and is small and only visible on a specific background.

The HP P4827 display does not have more than:

- 10 total dot defects.
- 7 defective red sub-pixels.
- 7 defective green sub-pixels.
- 7 defective blue sub-pixels.
- No more than two adjacent (less than 2.5 mm edge-to-edge) and defective sub-pixels.
- No more than two pairs of two adjacent defective sub-pixels.

To locate defective pixels, the monitor should be viewed under normal operating conditions and in normal operating mode at a supported resolution and refresh rate, from a distance of approximately 50 cm (16 in.).

HP expects that, over time, the industry will continue to improve its ability to produce displays with fewer cosmetic imperfections and HP will adjust guidelines as improvements are made.

## Technical Specifications

Liquid Crystal Display (LCD)	Display Size	17 in. (43 cm) diagonal and viewable image
	Type	TFT liquid crystal display
Input Signal	Video	0.7 V (0,7) p-p analog RGB
	Synchronization	Separated H/V (TTL level)
Interface	Input Connector	15-pin D-SUB (Analog) DVI-D (Digital)
Scanning Frequency	Horizontal	30–80 kHz
	Vertical	56–75 Hz
Resolution (H x V)	Maximum	1280 x 1024 @ 75 Hz
	Recommended	1280 x 1024 @ 60 Hz
Power Source	AC/DC Adapter	Input Rating: 100–240 V~ auto-range, 2 A max. Output Rating: 12 V ---, 4.16 A (4,16 A) Frequency: 50-60 Hz
	Base Unit	Input Voltage: 12 V --- Input Current: 3.5 A (3,5 A)
Power Consumption		Operating mode: less than 60W when operating with 4 USB devices. Sleep mode: less than 3 W
Operating Environment	Temperature	10° C to 35° C
	Humidity	20% RH through 80% RH (without condensation)
Storage Environment	Temperature	-10° C to 60° C
	Humidity	8% RH through 85% RH (without condensation)
Dimensions (H x W x D)		420 x 48 x 480 mm (16.5 x 1.9 x 18.9 in)
Weight		7.5 kg (7,5 kg) 16.5 lb
Tilt Stand	Tilt Angle: Down 5, up 25 degrees	
Swivel Angle	180° (-/+)	
Security Lock	Monitor cabinet is provided with two slots allowing the use of a Kensington™ lock device	

---

## Care and Cleaning

*To maximize the screen life span of this product and to prevent damage to the liquid crystal display, it is recommended that you:*

- Do not let liquid get on or into the monitor.
- Do not store or use the monitor in locations exposed to heat, direct sunlight, or extreme cold.
- Do not store or use the monitor in a dusty environment or in locations exposed to high humidity.
- Do not press sharp or pointed objects against the monitor.
- Avoid touching or pressing the screen of the monitor.
- Avoid setting contrast and brightness to their maximum levels for prolonged periods.
- Turn off the monitor when not in use.
- Do not place anything on or against the audio base (multimedia models only).
- Use a soft brush or cloth to clean the audio base (multimedia models only).
- Clean the screen with isopropyl alcohol or ethyl alcohol diluted with water (1:1) to prevent damage to the screen's anti-glare coating.

*To clean the screen:*

- 1 Turn off the monitor and remove the power plug (pull the plug, not the cable).
- 2 Soak a soft gauze cloth with isopropyl alcohol or ethyl alcohol diluted with water (1:1) and gently wipe the surface of the monitor. Do not dust it or wipe it with a cloth dampened with pure water.
- 3 Dry with a clean, soft cotton cloth.

---

**CAUTION:** **Never use pure water to clean the LCD screen. Do not use cleaning solutions containing fluoride, acids, or alkalis. Do not use ketone substances such as acetone or solvents such as xylene or toluene to clean the monitor. Do not use benzene, thinner, ammonia, or any volatile substance to clean the monitor's screen or cabinet. These chemicals may damage the monitor.**

---



## **Environmental Information**

HP has a strong commitment to the environment. The HP monitor has been designed with respect for the environment as much as possible.

HP can also take back your old monitor for recycling when it reaches the end of its useful life.

HP has a product take-back program in several countries. The collected equipment is sent to one of HP's recycling facilities in Europe or the USA. As many parts as possible are reused. The remainder is recycled. Special care is taken with batteries and other potentially toxic substances; these are reduced to harmless components through a special chemical process.

If you require more details about HP's product take-back program, contact your dealer or your nearest HP sales office.

## Regulatory Information

### DECLARATION OF CONFORMITY

According to ISO/IEC Guide 22 and CEN/CENELEC EN 45014

**Manufacturer's name:** HEWLETT-PACKARD France  
**Manufacturer's address:** 5 Avenue Raymond Chanas-Eybens  
38053 GRENOBLE Cedex 09 - FRANCE

**Declares that the LCD Color Monitor**

Product Name	L1725 (17")
Model Number	<b>P4827**</b>

(\* can be any alphanumerical character)

**Conforms to the following Product Specifications:**

SAFETY

- UL 1950 3<sup>rd</sup> edition

▪ ELECTRO-MAGNETIC COMPATIBILITY

- FCC Title 47 CFR, Part 15 Class B <sup>(1)</sup>  
- ICES-003, Issue 3

<sup>(1)</sup> This device complies with Part 15 of the FCC rules. Operation is subject to the following two conditions:

- a- This device may not cause harmful interference, and
- b- This device must accept any interference received, including interference that may cause undesired operation.

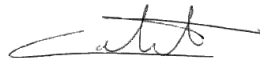

Grenoble  
January 2002

Didier CABARET  
Quality Manager

**For Compliance Information ONLY, contact :**

USA contact : Hewlett Packard Company, Corporate Product Regulations Manager  
3000 Hanover Street, Palo Alto, CA 94304. (Phone (+1) (650) 857-1501)

## **Notice for the USA: FCC Class B Statement**

### *Federal Communications Commission Radio Frequency Interference Statement Warning:*

This equipment has been tested and found to comply with the limits for a Class B digital device, pursuant to Part 15 of the FCC Rules. These limits are designed to provide reasonable protection against harmful interference in a residential installation. This equipment generates, uses, and can radiate radio frequency energy and, if not installed and used in accordance with the instructions, may cause harmful interference to radio communications. However, there is no guarantee that interference will not occur in a particular installation. If this equipment does cause harmful interference to radio or television reception, that can be determined by turning the equipment off and on, the user is encouraged to correct the interference by one or more of the following measures:

- Reorient or relocate the receiving antenna.
- Increase the distance between the equipment and the receiver.
- Connect the equipment to an outlet on a different circuit to the one the receiver is connected to.
- Consult your dealer or an experienced radio/TV technician for help.

## **Safety Warning for USA**

If the power cord is not supplied with the monitor, select the proper power cord according to your national electric specifications.

- USA: use a UL listed type SVT detachable power cord.

## **Notice for Canada**

This Class "B" digital apparatus complies with all requirements of the Canadian Interference-Causing Equipment Regulations (ICES.003).

Cet appareil numérique de la Classe B est conforme a la norme MB-003 du Canada.



## TCO '99

Congratulations! You have just purchased a TCO '99 approved and labeled product! Your choice has provided you with a product developed for professional use. Your purchase has also contributed to reducing the burden on the environment and to the further development of environmentally adapted electronics products.

This product meets the requirements for the TCO '99 scheme which provides for an international environmental and quality labeling of personal computers. The labeling scheme was developed as a joint effort by the TCO (The Swedish Confederation of Professional Employees), Svenska Naturskyddsforeningen (The Swedish Society for Nature Conservation), Statens Energimyndighet (The Swedish National Energy Administration), and SEMKO AB.

The requirements cover a wide range of issues: environmental, ergonomic, usability, reduction of electric and magnetic fields, energy consumption and electrical safety.

### *Why do we have environmentally labeled computers?*

In many countries, environmental labeling has become an established method for encouraging the adaptation of goods and services to the environment. The main problem, as far as computers and other electronics equipment are concerned, is that environmentally harmful substances are used both in the products and during their manufacture. Since it is not so far possible to satisfactorily recycle the majority of electronics equipment, most of these potentially damaging substances sooner or later enter nature.

There are also other characteristics of a computer, such as energy consumption levels, that are important from the viewpoints of both the work (internal) and natural (external) environments. Since all methods of electricity generation have a negative effect on the environment (for example, acidic and climate-influencing emissions, radioactive waste), it is vital to save energy. Electronics equipment in offices is often left running continuously and thereby consumes a lot of energy.

### *What does the environmental labeling involve?*

The environmental demands have been developed by Svenska Naturskyddsforeningen (The Swedish Society for Nature Conservation). These demands impose restrictions on the presence and use of heavy metals, brominated and chlorinated flame retardants, CFCs (freons) and chlorinated solvents, among other things. The product must be prepared for recycling, and the manufacturer is obliged to have an environmental policy which must be adhered to in each country where the company implements its operational policy.

The energy requirements include a demand that the computer and/or monitor, after a certain period of inactivity, shall reduce its power consumption to a lower level in one or more stages. The length of time to reactivate the computer shall be reasonable for the user.

Below, you will find a brief summary of the environmental requirements met by this product. The complete environmental criteria document may be ordered from:

TCO Development

SE-114 94 Stockholm, Sweden

Fax: +46 8 782 92 07

Email (Internet): [development@tco.se](mailto:development@tco.se)

Current information regarding TCO '99 approved and labeled products may also be obtained over the Internet, using the address:

[www.tco-info.com](http://www.tco-info.com)

## Environmental requirements

### *Flame retardants:*

Flame retardants are present in printed circuit boards, cables, wires, casings and housings. Their purpose is to prevent, or at least to delay, the spread of fire. Up to 30% of the plastic in a computer casing can consist of flame retardant substances. Most flame retardants contain bromine or chloride, and those flame retardants are chemically related to another group of environmental toxins, PCBs. Both the flame retardants containing bromine or chloride and the PCBs are suspected of giving rise to severe health effects, including reproductive damage in fish-eating birds and mammals, due to the bio-accumulative\* processes. Flame retardants have been found in human blood and researchers fear that disturbances in foetus development may occur.

The relevant TCO '99 demand requires that plastic components weighing more than 25 grams must not contain flame retardants with organically bound bromine or chlorine. Flame retardants are allowed in the printed circuit boards since no substitutes are available.

### *Cadmium:\*\**

Cadmium is present in rechargeable batteries and in the colour-generating layers of certain computer displays. Cadmium damages the nervous system and is toxic in high doses. The relevant TCO '99 requirement states that batteries, the colour-generating layers of display screens and the electrical or electronics components must not contain any cadmium.

*Mercury:\*\**

Mercury is sometimes found in batteries, relays and switches. It damages the nervous system and is toxic in high doses. The relevant TCO '99 requirement states that batteries may not contain any mercury. It also demands that mercury is not present in any of the electrical or electronics components associated with the labeled unit. There is however one exception. Mercury is, for the time being, permitted in the back light system of flat panel monitors as there today is no commercially available alternative. TCO aims on removing this exception when a mercury free alternative is available.

*CFCs (freons):*

The relevant TCO '99 requirement states that neither CFCs nor HCFCs may be used during the manufacture and assembly of the product. CFCs (freons) are sometimes used for washing printed circuit boards. CFCs break down ozone and thereby damage the ozone layer in the stratosphere, causing increased reception on earth of ultraviolet light with e.g. increased risks of skin cancer (malignant melanoma) as a consequence.

*Lead:\*\**

Lead can be found in picture tubes, display screens, solders and capacitors. Lead damages the nervous system and in higher doses, causes lead poisoning. The relevant TCO '99 requirement permits the inclusion of lead since no replacement has yet been developed.

\* Bio-accumulative is defined as substances which accumulate within living organisms.

\*\* Lead, Cadmium and Mercury are heavy metals which are Bio-accumulative.

## Hardware Warranty

### HP General Hardware Warranty

This HP Monitor Hardware Warranty Statement gives you, the customer, express warranty rights from HP, the manufacturer.

FOR CONSUMER TRANSACTIONS IN AUSTRALIA AND NEW ZEALAND: THE WARRANTY TERMS CONTAINED IN THIS STATEMENT, EXCEPT TO THE EXTENT LAWFULLY PERMITTED, DO NOT EXCLUDE, RESTRICT OR MODIFY AND ARE IN ADDITION TO THE MANDATORY STATUTORY RIGHTS APPLICABLE TO THE SALE OF THIS PRODUCT TO YOU.

THE LAWS OF YOUR COUNTRY MAY PROVIDE FOR DIFFERENT WARRANTY RIGHTS. IF SO, YOUR AUTHORIZED HP DEALER OR HP SALES AND SERVICE OFFICE CAN PROVIDE YOU WITH DETAILS.

Warranty repair or replacement.

Model	Warranty Period	Service Provided	
P4827	3 years unless original end-user customer has otherwise agreed to a shorter period of warranty at the time of purchase.	US & Canada Only: 3 years second next business day on-site exchange (direct replacement).	F
		Europe only: 3 years next business day on-site exchange (swap out).	E
		Rest of the world: On-site service for first year, and return to an HP or repair-authorized center for the following two years.	A
	1 year	Japan: Return to HP or a repair-authorized service center for one year.	D

Hewlett-Packard (HP) warrants this monitor hardware product, or accessory against defects in materials and workmanship for the applicable warranty period stated above, commencing from the date of delivery of the product to the end-user customer.

HP does not warrant that the HP hardware will operate uninterrupted or error free.

If, during the product warranty period, HP is unable, within a reasonable time, to repair or replace your product to the condition as warranted, you will be entitled to a refund (in the amount of the product purchase price) upon prompt return of the product to your authorized HP dealer or other HP designate. Unless otherwise stated or agreed upon in writing with HP, all hardware components must be returned for refund with the entire system process unit. HP software is covered by the HP Software Product Limited Warranty located in your HP product manual. Unless otherwise stated, and to the extent permitted by local law, hardware products may contain remanufactured parts (equivalent to new in performance) or parts which may have been subject to prior

incidental use. HP may repair or replace hardware products (i) with products which are equivalent in performance to the products being repaired or replaced but which may have been subject to prior use, or (ii) with products which may contain remanufactured parts equivalent to new in performance or parts which may have been subject to prior incidental use.

### *Proof of Purchase and Warranty Period*

In order to receive service or support for your hardware product for the warranty period, proof of the original purchase date of the product may be required in order to establish the delivery date of your product. If the delivery date is not available, either the purchase date or the manufacturer's date (located on the product) becomes the beginning of the warranty period.

### *Limitation of Warranty*

Warranty does not apply to defects resulting from: (a) improper or inadequate maintenance or calibration; (b) software, interfacing, parts or supplies not supplied by HP; (c) unauthorized repair, maintenance, modification or misuse; (d) operation outside of the published operating specifications for the product; (e) improper site preparation or maintenance; or (f) such other exclusions as may be expressly set forth in this Warranty Statement.

HP MAKES NO OTHER EXPRESS WARRANTY, WHETHER WRITTEN OR ORAL, WITH RESPECT TO THIS PRODUCT.

TO THE EXTENT ALLOWED BY APPLICABLE LOCAL LAW, ANY IMPLIED WARRANTY OF MERCHANTABILITY OR FITNESS FOR A PARTICULAR PURPOSE IS LIMITED TO THE DURATION OF THE EXPRESS WARRANTY SET FORTH ABOVE.

### *Limitation of Liability and Remedies*

TO THE EXTENT ALLOWED BY APPLICABLE LOCAL LAW, THE REMEDIES IN THIS WARRANTY STATEMENT ARE YOUR SOLE AND EXCLUSIVE REMEDIES. IN NO EVENT SHALL HP BE LIABLE FOR LOSS OF DATA OR FOR DIRECT, INDIRECT, SPECIAL, INCIDENTAL, OR CONSEQUENTIAL DAMAGE, WHETHER BASED ON WARRANTY CONTRACT, TORT, OR ANY OTHER LEGAL THEORY.

The foregoing limitation of liability shall not apply in the event that any HP product sold hereunder is determined by a court of competent jurisdiction to be defective and to have directly caused bodily injury, death, or property damage. To the extent allowed by applicable local law, HP's liability for property damage does not exceed the greater of \$50,000 or the purchase price of the specific product that caused such damage.





i n v e n t